

gez: Gangflügel DIN links  
 Gangflügel DIN rechts spiegelbildlich

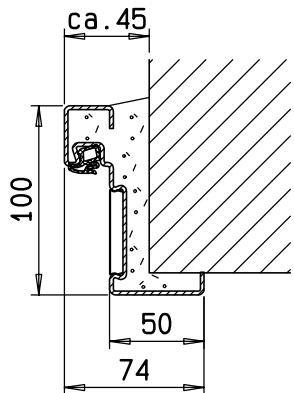

Zarge "ZNG 68/76", optional

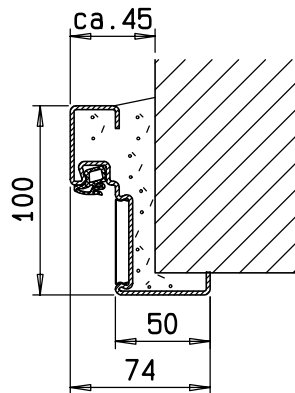

Zarge "ZNG 58/76", optional bei Dickfalz

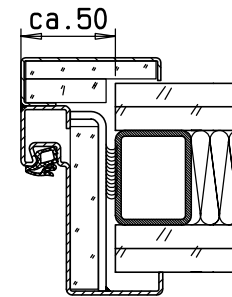

Zarge "ZG 68/76"

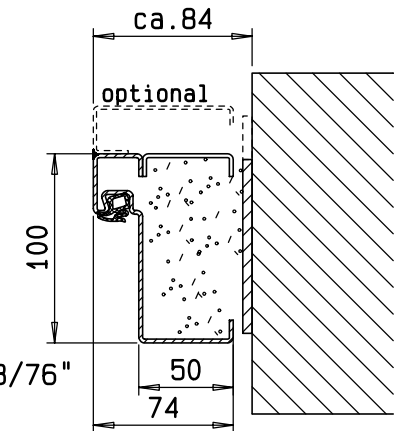

Zweiflügelige Rauchschutztür  
 "System Schröders RSN-2"

Horizontalschnitt

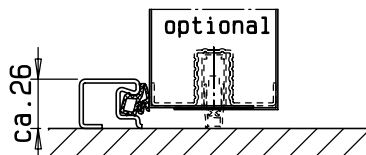
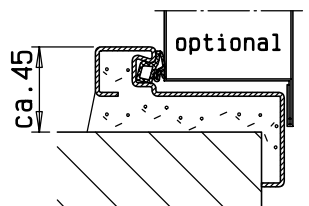
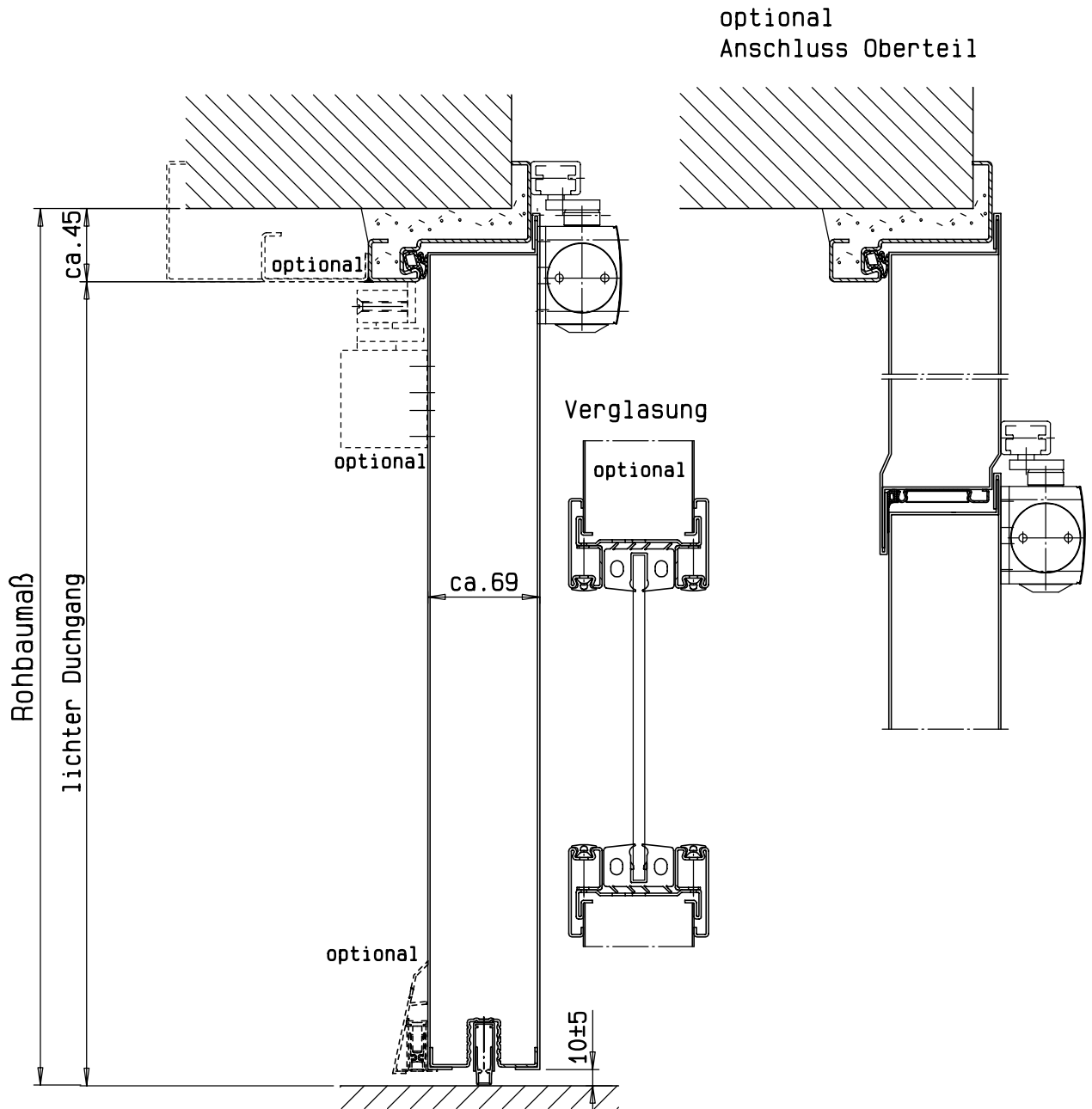

Einbau- bzw. Zargenvarianten  
siehe Horizontalschnitt



Zweiflügelige Rauchschutztür  
"System Schröders RSN-2"

Vertikalschnitt